

GRV 1500S

Oil Coolers GRV Series

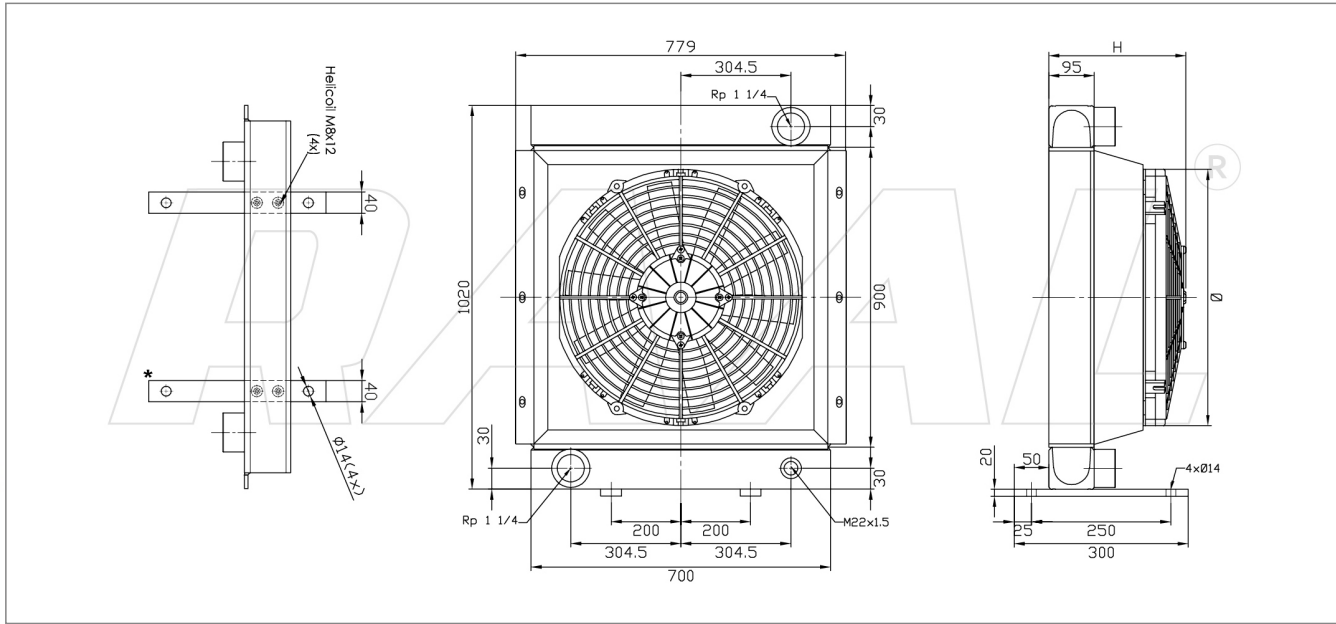

[*] Removable feet

Gamma Oil Coolers

Product Code	Type of Setting	Overall H	Fan diameter	Fan Power m3/h	M.R. dm3	Power Consumpt.
RU0105730000	UNCOVERED	95	-	-	59,85	-
RU0105730411	12V Suct.	290	4 x 305	7356	59,85	66,0 A
RU0105730412	12V Blow.	290	4 x 305	6944	59,85	59,6 A
RU0105730421	24V Suct.	290	4 x 305	8644	59,85	41,2 A
RU0105730422	24V Blow.	290	4 x 305	8200	59,85	36,4 A
RU0105730031/32	230V-50/60Hz Suct./Blow.	320	630	11025	59,85	2,62 A
RU0105730431/32	230V-50/60Hz Suct./Blow.	255	4 x 300	14980	59,85	6,2 A
RU0105730041/42	230/400V-50/60Hz 3FN Suct./Blow.	320	630	11270	59,85	1,2 A
RU0105730441/42	230/400V-50/60Hz 3FN Suct./Blow.	255	4 x 300	13400	59,85	1,92 A
RU0105730051	Pred. Hydraulic. Suct. (Supp. G2)	325	630	23600	59,85	7,4 kW
RU0105730052	Pred. Hydraulic. Blow. (Supp. G2)	325	630	23600	59,85	7,4 kW

Technical Specification

Minimum Range

Kw 58 : 60 lt

Maximum Range

Kw 78 : 280 lt

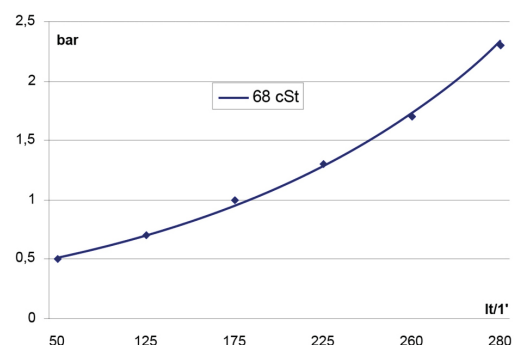
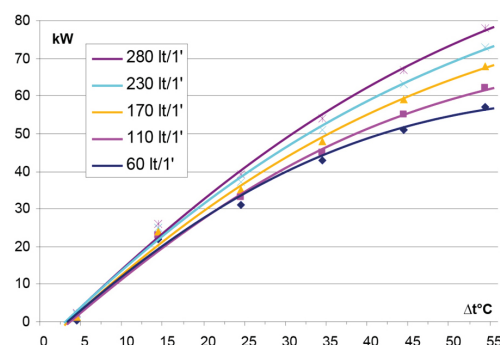

The overall dimensions and the technical characteristics are to be considered indicative, dealing with standard products in constant evolution.

