

# GO

## Goldoni

Goldoni D.29970

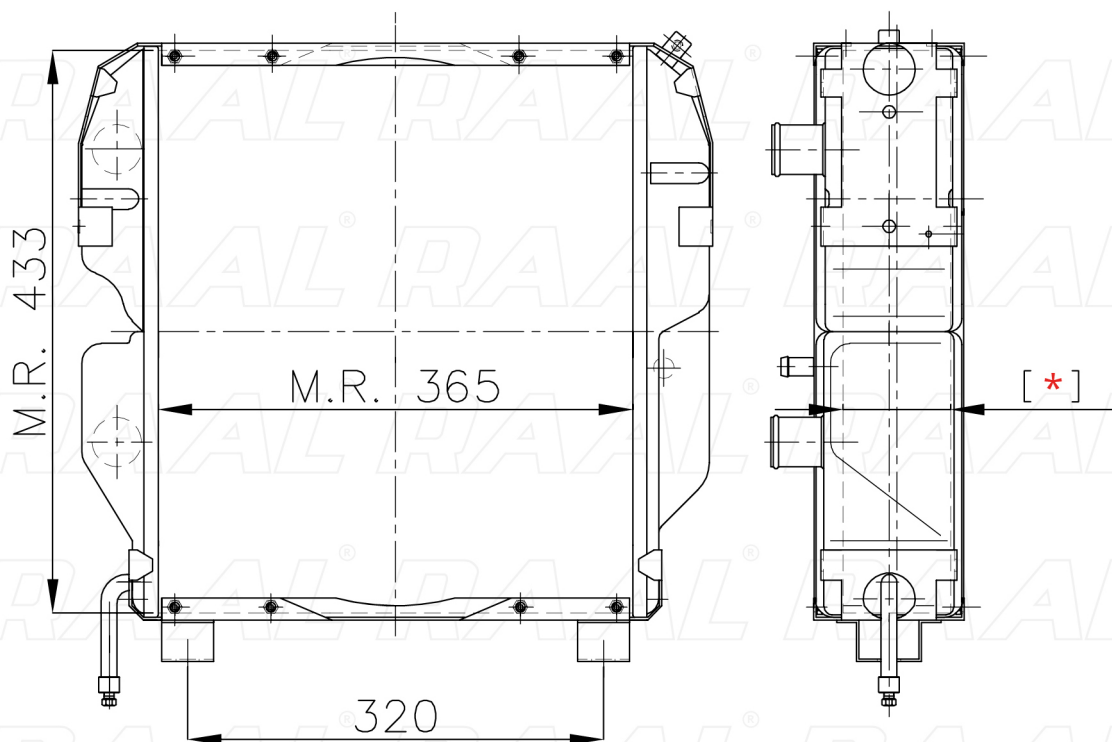

[ \* ] Le dimensioni indicate sono da considerarsi indicative in quanto possono variare a seconda del sistema costruttivo / The shown dimensions are indicative because they can vary according to the construction system.

### Informazioni prodotto / Product information

Marca / Brand	Goldoni
Modello / Model	Goldoni D.29970
Codice RAAL ITALIA / Code	RAOGO0230018
O.E.M.	-
Massa Radiante (mm) / Core Dimension	365 x 433 x [ * ]
Tecnologia / Technology	Rame-Ottone / Copper-Brass

